

6

5

4

3

2

1

MATERIAL AND FINISH:

Insulator: Polycarbonate, UL-94V-0 rated
Contacts: Brass
Screw: Brass, Nickel Plated over Copper
Nut: Brass, Nickel Plated

ELECTRICAL SPECIFICATIONS:

Current rating: 10 A/15 A
Voltage rating: 250 VAC
Insulation resistance: 100 Mohm min. at 500 VDC
Dielectric withstanding voltage: 2000 VAC for one minute

ORDERING CODE:





43R02-2 1
 1 2

- 1) COLOR
- 1 = BLACK
- 2 = GRAY

2) ELECTRICAL CIRCUIT CONFIGURATION

1 = 10A 250V 70°C 

15A 250V 70°C   

2 = 10A 250V 120°C 
15A 250V 120°C   

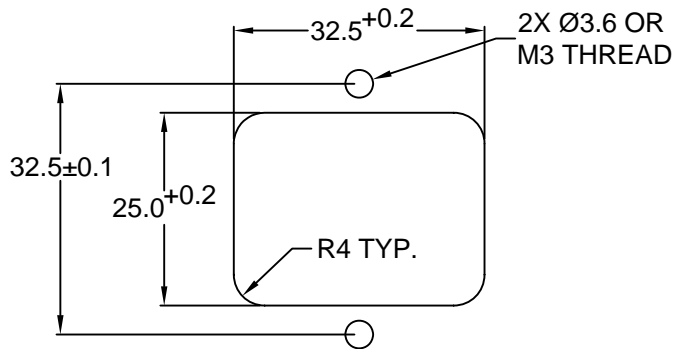
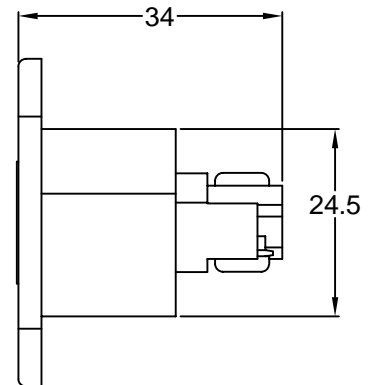
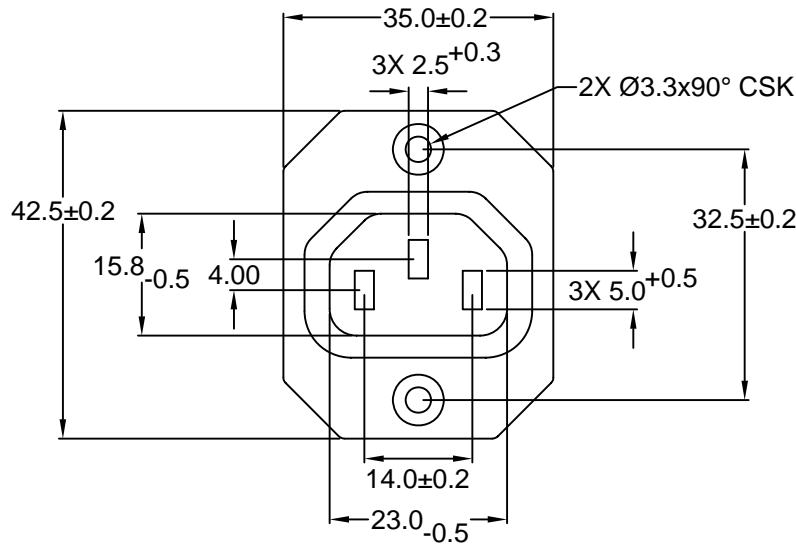
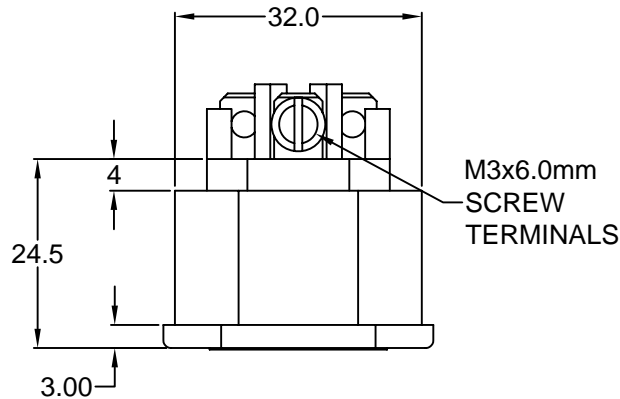

RECOMMENDED
PANEL CUTOUT

RoHS
COMPLIANT

TOLERANCE UNLESS OTHERWISE SPECIFIED	
X	± 1
X.X	± 0.4
X.XX	± 0.20

Power Dynamics, Inc.

Phone: 973 560-0019 Whippany, New Jersey Fax: 973 560-0076

PART: 10A/15A IEC 60320 APPL. OUTLET; SCREW
TERMINALS; CROSS FLANGE, PANEL MOUNT

DRAWN BY	GQ	DATE:	10/04/01
CHECK BY	TD	DATE:	10/10/01
APPR BY	PB	DATE:	10/10/01

PART #: 43R02-2X1X		SHEET 1 of 1
SIZE: A	ALL DIMENSIONS FOR REFERENCE ONLY DIMENSIONS ARE IN MILLIMETERS	REV:
SCALE: NTS		

REVISIONS	CHANGE	CHK	CHK	APPR
REV	DATE			

6

5

4

3

2

1