

- NOTES:
- ELECTRICAL:
 - IMPEDANCE: 50 OHM NOMIAL
 - FREQUENCY RANGE: DC-9 GHz
 - VSWR (RETURN LOSS): 25dB, DC to 3GHz
20dB, DC to 6GHz
12dB, DC to 9GHz
 - D. W. V: 750 VRMS, MIN
 - CENTER CONTACT REISTANCE: $\leq 20m\Omega$
 - OUT CONDUCTOR RESISTANCE: $\leq 5m\Omega$
 - MECHANICAL:
 - Mating cycles ≥ 25
 - Engagement force $\leq 45N$
 - Disengagement force $\geq 5N$
 - Retention force lachth $\geq 110N$
 - Coding efficiency $\geq 200N$
 - ENVIRIOMENTAL DATA:
 - TEMPERATURE RANGE: $-40^{\circ}C$ to $+105^{\circ}C$
 - Thermal shock : (ISO 20860-2 clause 9.2)
 - Temperature and huimidity: (ISO 20860-2 clause 9.3)
 - Vibration and mechanical shock: (ISO 20860-2 clause 9.1)
 - RoHS: Compliant
 - PART NUMBER:

101*00001 Mates with 102x00001 series

CODEING: SEE TABLE

CODING TABLE

Plug	Coding	P/N	Color	Ral NO.
	A	101A00001	Black	9005
	B	101B00001	White	9010
	C	101C00001	Blue	5012
	D	101D00001	Claret	4004
	E	101E00001	Green	6002
	F	101F00001	Brown	8011
	Z	101Z00001	Waterblue	5021

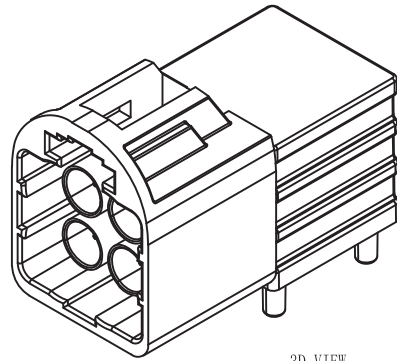

3D VIEW

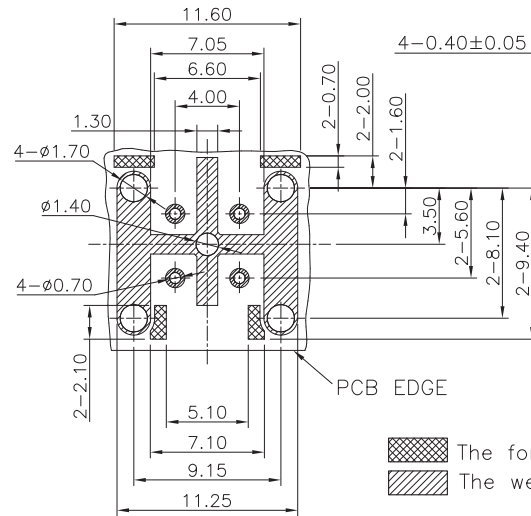
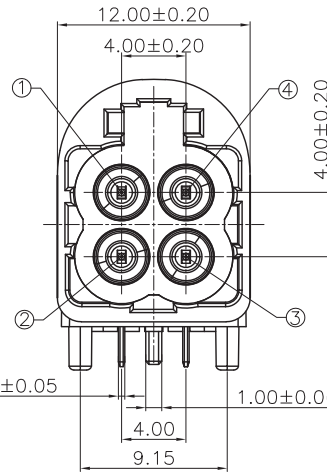

RECOMMENDED PCB LAYOUT
TOP VIEW (TOLRANCE: ± 0.05)

The forbidden welding area
 The welding area

ECN NO.	REV	DATE	DESCRIPTION	MDF'D	APP'D
	A0	2022. 09. 23	Initial version	LEo	JJW

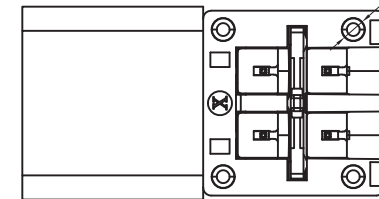
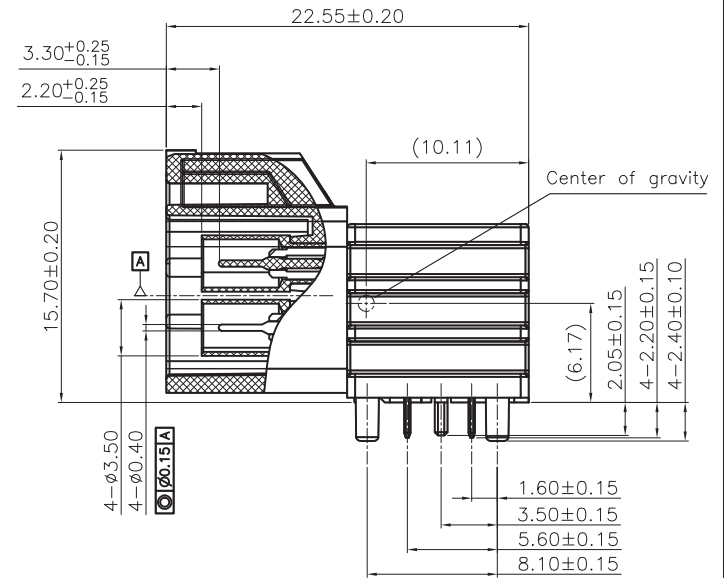

6	copper pipe	4	C5191	Ni 80u" Min,matte Tin 100u" Min
5	Contact	4	C2680	Au:10u", Sokdering area matte Tin100u" Min
4	Baffle	1	C2680	Ni100u" Min. matte Tin 100u" Min
3	Body	1	Zinc	Ni100u" Min. matte Tin 100u" Min
2	Insulator	4	LCP	Natural
1	Housing	1	PA-10T	See table1
NO	Part name	Number	Material	Plating / Color

General Tolerance		Angle Tolerance	
<0.5	± 0.10	$\pm 1^{\circ}$	
0.5-6	± 0.15	Unless otherwise specified, dimensions are in metric and tolerances are	
6-30	± 0.20		
30-120	± 0.30		
MATL: SEE-NOTES		CUSTOMER-DRAWING	

DESIGNER	LEo	TITLE:	4 pin Mini Fakra R/A PCB Plug
CHECKED	LEo	PARTS NO:	101x00001
APPROVAL	JJW	(UNIT): mm	(SCALE): 1:1 (SHT): 1/3

POWER DYNAMICS INC.

145 Algonquin Parkway, Whippany, NJ 07981

Phone: 1-973-560-0019

e-mail: sales@powerdynamics.com

www.powerdynamics.com

DESIGNER

LEo

TITLE:

4 pin Mini Fakra R/A PCB Plug

CHECKED

LEo

PARTS NO:

101x00001

APPROVAL

JJW



(UNIT): mm

(SCALE): 1:1

(SHT): 1/3

4		3		2		1	
ECN NO.	REV	DATE	DESCRIPTION		MDF'D	APP'D	
	A0	2022. 09. 23	Initial version		LEo	JJW	

CODING TABLE

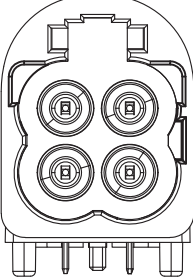
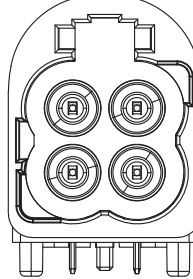
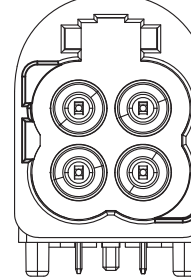
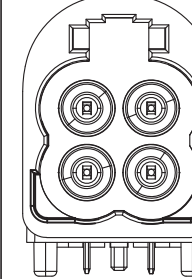
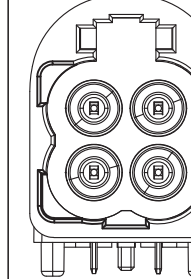
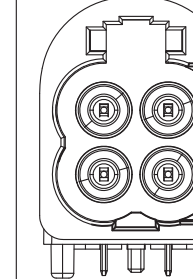
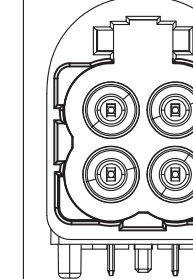
	101A00001	101B00001	101C00001	101D00001	101E00001	101F00001	101Z00001
							
Coding	A	B	C	D	E	F	Z
Color	JET BLACK	CREAM	SIGNAL BLUE	CLARET VIOLET	LEAF GREEN	NUT BROWN	WATER BLUE
Ral NO.	9005	9010	5012	4004	6002	8011	5021

General Tolerance		Angle Tolerance	POWER DYNAMICS INC.			
<0.5	±0.10	±1°	145 Algonquin Parkway, Whippany, NJ 07981			
0.5-6	±0.15		Phone: 1-973-560-0019	e-mail: sales@powerdynamics.com		www.powerdynamics.com
6-30	±0.20		DESIGNER: LEo TITLE: 4 pin Mini Fakra R/A PCB Plug CHECKED: LEo PARTS NO: 101x00001			
30-120	±0.30					
MATL: SEE-NOTES		Unless otherwise specified, dimensions are in metric and tolerances are	APPROVAL	JJW		(UNIT): mm (SCALE): 1:1 (SHT): 2/3
CUSTOMER-DRAWING						

ECN NO.	REV	DATE	DESCRIPTION	MDF'D	APP'D
	A0	2022. 9. 23	Initial version	LEo	JJW

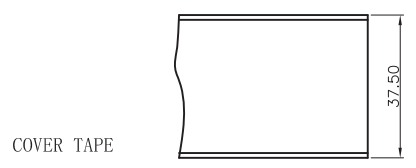
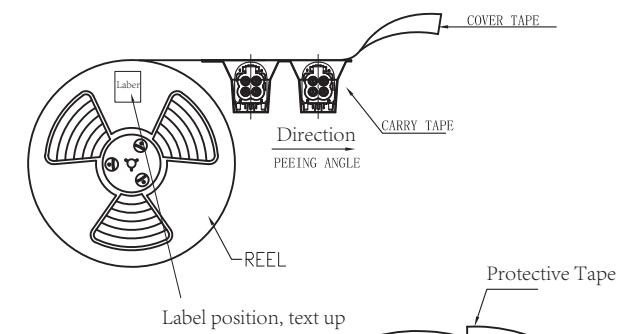
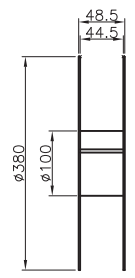
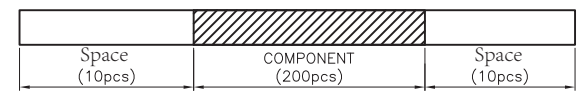
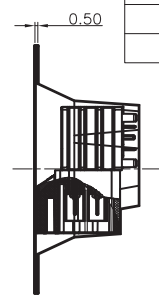
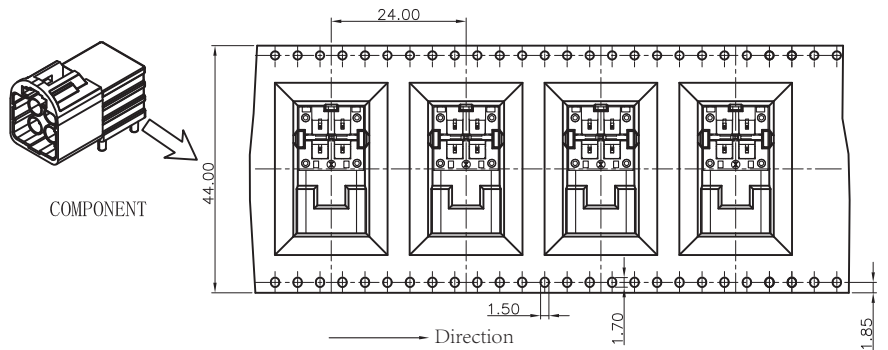

HDPE Bag, Specifications 500*430 T=0.12mm Put 5 bag desiccant inside, Hot sealing

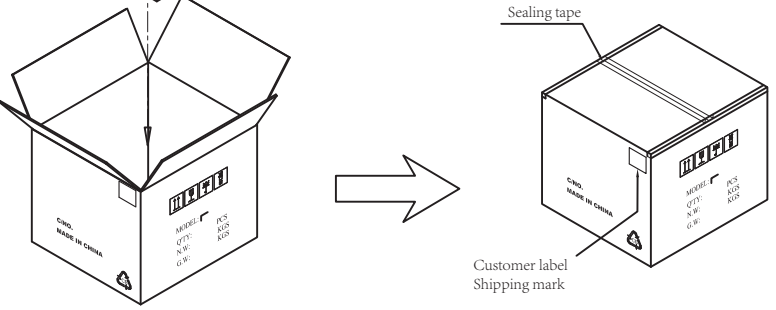
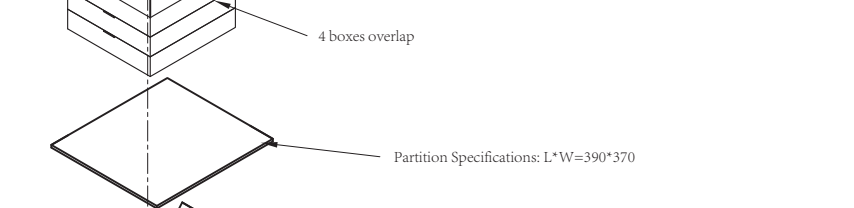
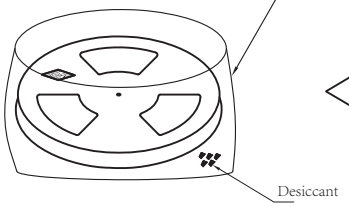
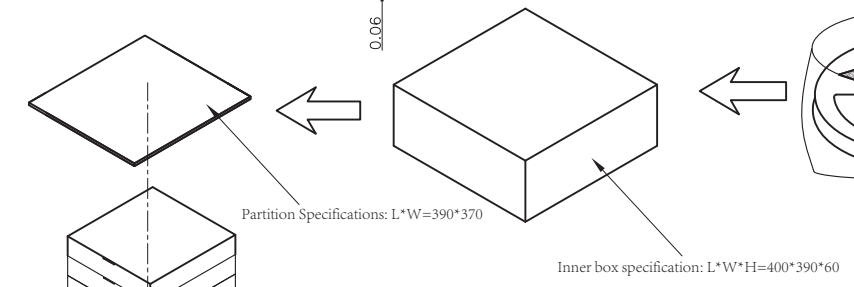

1. Packaging method
 - 1.1 Place the products in the Carry-Tyape in the same direction as shown in the figure, with 1 pcs in each slot and 10 empty slots in the front.
 - 1.2 Put the finished product Reel into the HDPE bag, seal it and put it into the inner carton, 1R/inner carton, fold the four inner cartons and put them into the outer carton, and put one cardboard at the bottom and top respectively.
2. The inner label is pasted on the side of the oval hole of the carrier belt, and the label format is in accordance with the business requirements.
3. Sealing force of coil tape 50g-140g (cold sealing)
4. Package quantity: 200pcs/Reel; 800pcs/Carton
5. Carton size: 420 * 405 * 270mm, Partition size: 390 * 370mm, Inner box size: 400 * 390 * 60mm
6. The outer box is sealed with transparent tape, and the reel is 15 ".

Unless otherwise specified, dimensions are	POWER DYNAMICS INC. 145 Algonquin Parkway, Whippany, NJ 07981				
	Phone: 1-973-560-0019		e-mail: sales@powerdynamics.com		www.powerdynamics.com
DESIGNER	LEo	TITLE: 4 pin Mini Fakra R/A PCB Plug			
MATL: SEE-NOTES	CHECKED	LEo	PARTS NO: 101x00001		
PACKAGING-DRAWING	APPROVAL	JJW		(UNIT): mm	(SCALE): 1:1 (SHT): 3/3